



3200W AC/DC High Reliable Industrial Enclosed Type Power Supply **NSP-3200** series



Front



Back



■ Features

- 90~264Vac input with PFC
- Output voltage 50~125% programmable
- Built-in CANBus protocol
- -20~+70°C wide range operation temperature
- Built-in constant current limiting circuit
- High efficiency up to 94.5%
- Built-in remote ON-OFF control / Remote Sense / 12Vaux power / DC OK signal / OTP alarm signal
- Built-in intelligent fan speed control
- Protections: Short circuit / Overload / Over voltage / Over temperature
- Design refer to SEMI F47 at 200Vac
- 5 years warranty

■ Applications

- Factory control or automation apparatus
- Test and measurement instrument
- Laser related machine
- Aging facility
- Digital broadcasting
- Constant current source

■ GTIN CODE

MW Search: <https://www.meanwell.com/serviceGTIN.aspx>

■ Description

NSP-3200 is a 3.2KW single output enclosed type AC/DC power supply with 1U low profile and a high power density up to 37W/inch³. This series operates for 90~264Vac input voltage and offers the models with the DC output mostly demanded by the industry. Each model is cooled by the thermostatically controlled fan. Moreover, NSP-3200 provides vast design flexibility by equipping various built-in functions such as output programming, remote ON-OFF control, auxiliary power, and etc.

■ Model Encoding

NSP - 3200 - 24

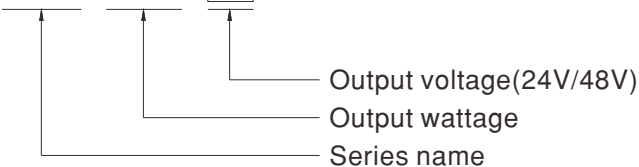



3200W AC/DC High Reliable Industrial Enclosed Type Power Supply **NSP-3200** series

SPECIFICATION		NSP-3200-24	NSP-3200-48
OUTPUT			
DC VOLTAGE		24V	48V
RATED CURRENT		133A	67A
CURRENT RANGE		0 ~ 133A	0 ~ 67A
RATED POWER		3192W	3216W
RIPPLE & NOISE (max.) Note.2		300mVp-p	480mVp-p
VOLTAGE ADJ. RANGE		23.5 ~ 30V	47.5 ~ 58.8V
VOLTAGE TOLERANCE Note.3		±1.0%	±1.0%
LINE REGULATION		±0.5%	±0.5%
LOAD REGULATION		±0.5%	±0.5%
SETUP, RISE TIME		1500ms, 60ms/230Vac at full load	
HOLD UP TIME (Typ.)		16ms / 230Vac at 70% load	8ms / 230Vac at full load
INPUT			
VOLTAGE RANGE Note.4		90 ~ 264Vac	127 ~ 400Vdc
FREQUENCY RANGE		47 ~ 63Hz	
POWER FACTOR (Typ.)		0.97/230Vac at full load	
EFFICIENCY (Typ.) Note.5		93.5%	94.5%
AC CURRENT (Typ.) Note.4		17A/230Vac	
INRUSH CURRENT (Typ.)		COLD START 55A/230Vac	
LEAKAGE CURRENT		<2mA / 230Vac	
PROTECTION			
OVERLOAD		105 ~ 115% rated output power Protection type : Constant current limiting , shut down O/P voltage 5 sec. after O/P voltage is down low, re-power on to recover	
OVER VOLTAGE		31.5 ~ 37.5V	63 ~ 75V
		Protection type : Shut down o/p voltage, re-power on to recover	
OVER TEMPERATURE		Shut down o/p voltage, recovers automatically after temperature goes down	
FUNCTION			
OUTPUT VOLTAGE PROGRAMMABLE(PV)		Adjustment of output voltage is allowable to 50 ~ 125% of nominal output voltage Please refer to the Function Manual in following pages	
REMOTE CONTROL		By electrical signal or dry contact Power ON:short Power OFF:open. Please refer to the Function Manual in following pages	
REMOTE SENSE		Compensate voltage drop on the load wiring up to 0.5Vdc. Please refer to the Function Manual in following pages	
AUXILIARY POWER		12Vaux @ 0.8A, tolerance ±10%	
ALARM SIGNAL		Isolated TTL signal output for T-Alarm and DC-OK. Please refer to the Function Manual in following pages	
CANBus INTERFACE		Communication provides functions such as control, setting and monitoring	
FAN SPEED CONTROL(Typ.)	Note.7	Built-in intelligent fan speed control detect by PSU'S internal temperature	
	10% load with Ta=25°C	38dB	38dB
	70% load with Ta=25°C	44dB	38dB
ENVIRONMENT			
WORKING TEMP.		-20 ~ +70°C (Refer to "Derating Curve")	
WORKING HUMIDITY		20 ~ 90% RH non-condensing	
STORAGE TEMP., HUMIDITY		-40 ~ +85°C, 10 ~ 95% RH non-condensing	
TEMP. COEFFICIENT		±0.03%/°C (0 ~ 50°C)	
VIBRATION		10 ~ 500Hz, 2G 10min./1cycle, 60min. each along X, Y, Z axes	
SAFETY & EMC (Note.8)			
SAFETY STANDARDS		UL62368-1, CSA C22.2 No. 62368-1, TUV BS EN/EN62368-1, BIS IS 13252(Part 1):2010/ IEC 60950-1 : 2005, EAC TP TC 004 approved	
WITHSTAND VOLTAGE		I/P-O/P:3KVac I/P-FG:2KVac O/P-FG:1.5KVac	
ISOLATION RESISTANCE		I/P-O/P, I/P-FG, O/P-FG:100M Ohms / 500Vdc / 25°C / 70% RH	
EMC EMISSION	Parameter	Standard	Test Level / Note
	Conducted	BS EN/EN55032 (CISPR32)	Class B
	Radiated	BS EN/EN55032 (CISPR32)	Class A
	Harmonic Current	BS EN/EN61000-3-2	Class A
	Voltage Flicker	BS EN/EN61000-3-3	-----
EMC IMMUNITY	BS EN/EN55024, BS EN/EN61000-6-2, design refer to SEMI F47 at 200Vac		
	Parameter	Standard	Test Level / Note
	ESD	BS EN/EN61000-4-2	Level 3, 8KV air ; Level 2, 4KV contact
	Radiated	BS EN/EN61000-4-3	Level 3
	EFT / Burst	BS EN/EN61000-4-4	Level 3
	Surge	BS EN/EN61000-4-5	2KV/Line-Line 4KV/Line-Earth
	Conducted	BS EN/EN61000-4-6	Level 3
	Magnetic Field	BS EN/EN61000-4-8	Level 4
	Voltage Dips and Interruptions	BS EN/EN61000-4-11	>95% dip 0.5 periods, 30% dip 25 periods, >95% interruptions 250 periods
OTHERS			
MTBF		637.4K hrs min. Telcordia SR-332 (Bellcore); 63.7K hrs min. MIL-HDBK-217F (25°C)	
DIMENSION		325.8*107*41mm (L*W*H)	
PACKING		2.24Kg;4pcs/10Kg/1.09CUFT	
NOTE			
1. All parameters NOT specially mentioned are measured at 230Vac input, rated load and 25°C of ambient temperature.			
2. Ripple & noise are measured at 20MHz of bandwidth by using a 12" twisted pair-wire terminated with a 0.1uf & 47uf parallel capacitor.			
3. Tolerance : includes set up tolerance, line regulation and load regulation.			
4. Derating may be needed under low input voltages. Please check the derating curve for more details.			
5. The efficiency is measured at 75% load.			
6. If use PV signal to adjust Vo, under certain operating conditions, ripple noise of Vo might slightly go over rating defined in this specification.			
7. FAN noise test set up according to ISO-7779.			
8. The power supply is considered a component which will be installed into a final equipment. All the EMC tests are been executed by mounting the unit on a 600mm*900mm metal plate with 1mm of thickness. The final equipment must be re-confirmed that it still meets EMC directives. For guidance on how to perform these EMC tests, please refer to "EMI testing of component power supplies." (as available on https://www.meanwell.com/Upload/PDF/EMI_statement_en.pdf)			
9. The ambient temperature derating of 3.5°C/1000m with fanless models and of 5°C/1000m with fan models for operating altitude higher than 2000m(6500ft).			
※ Product Liability Disclaimer : For detailed information, please refer to https://www.meanwell.com/serviceDisclaimer.aspx			



3200W AC/DC High Reliable Industrial Enclosed Type Power Supply **NSP-3200 series**

■ BLOCK DIAGRAM

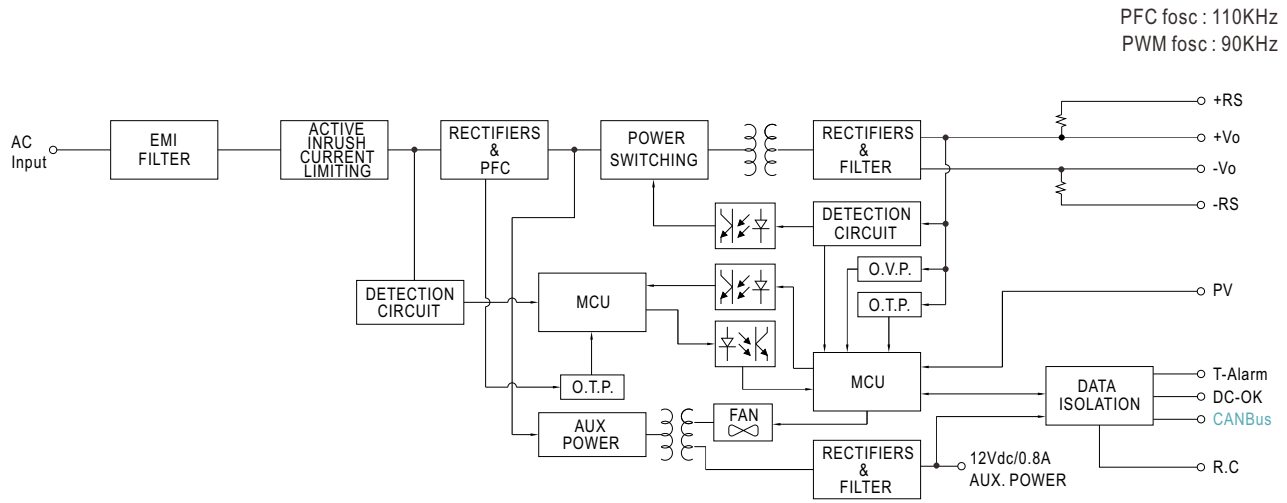

■ STATIC CHARACTERISTICS

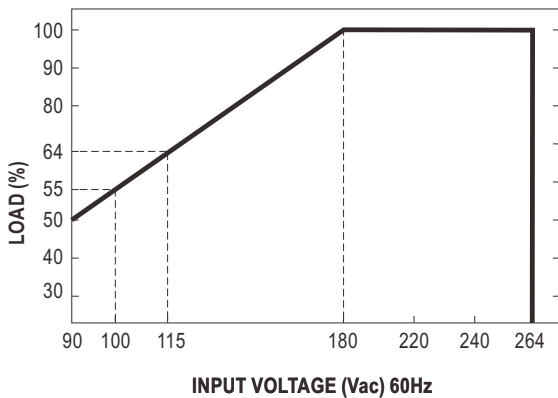

■ DERATING LOADs vs INPUT VOLTAGE

INPUT	MODEL	
	24V	48V
180~264Vac	3192W 133A	3216W 67A
90Vac	1596W 66.5A	1608W 33.5A

■ DERATING CURVE

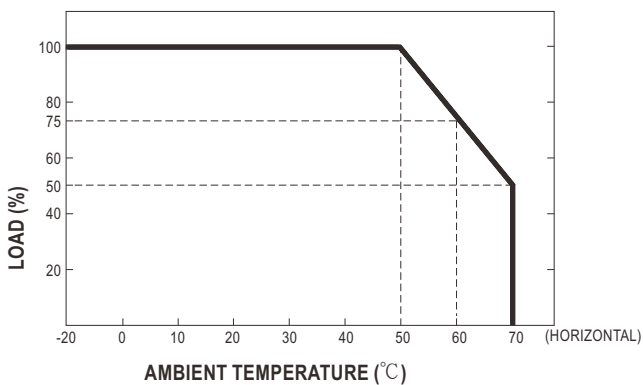

■ EFFICIENCY vs LOAD (48V MODEL)

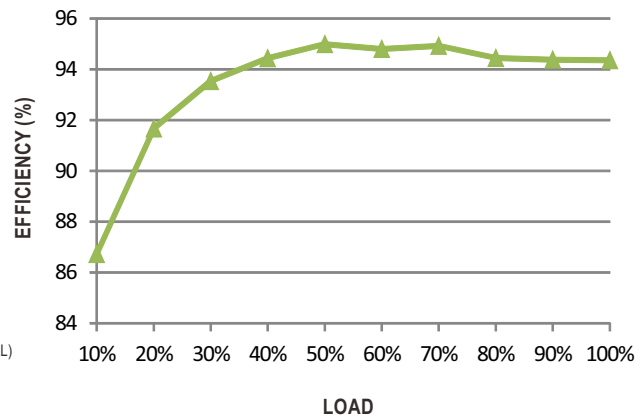

⊙ The curve above is measured at 230Vac.



3200W AC/DC High Reliable Industrial Enclosed Type Power Supply **NSP-3200** series

FUNCTION MANUAL

1. Output Voltage Programming (P.V)

※ In addition to the adjustment via the built-in potentiometer, the output voltage can be trimmed to 50~125% of the nominal voltage by applying External Voltage.

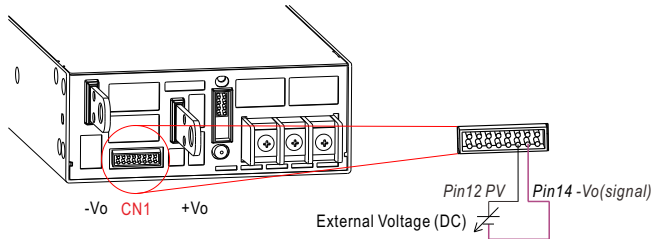

◎ For Remote Sense / Local Sense, please refer to "Voltage Drop Compensation" section.

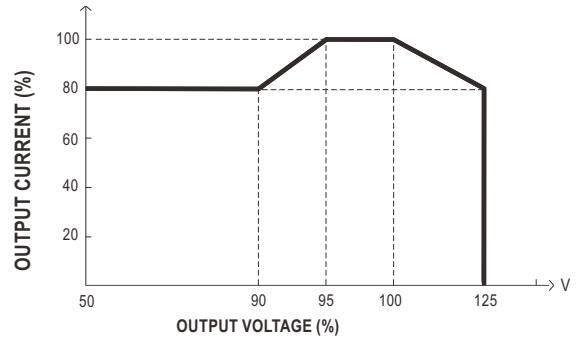
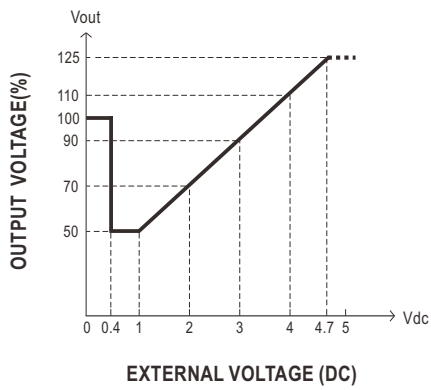

◎ The rated current should change with the Output Voltage Programming accordingly.

◎ For Remote Sense / Local Sense, please refer to "Voltage Drop Compensation" section.

2. Remote Control

※ The power supply can be turned ON/OFF individually or along with other units by using the "Remote Control" function.

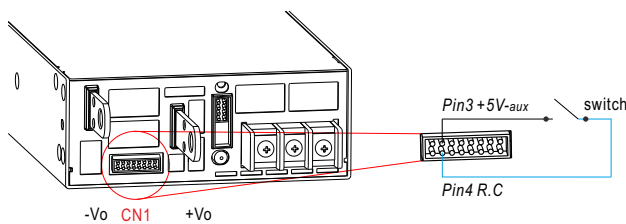

PSU Vo Status	Between +5V-aux(Pin 3) and R.C(Pin 4)
Power ON	Switch Short
Power OFF	Switch Open



3200W AC/DC High Reliable Industrial Enclosed Type Power Supply **NSP-3200 series**

3. Voltage Drop Compensation

3.1 Remote Sense

※ The Remote Sense compensates voltage drop on the load wiring up to 0.5Vdc

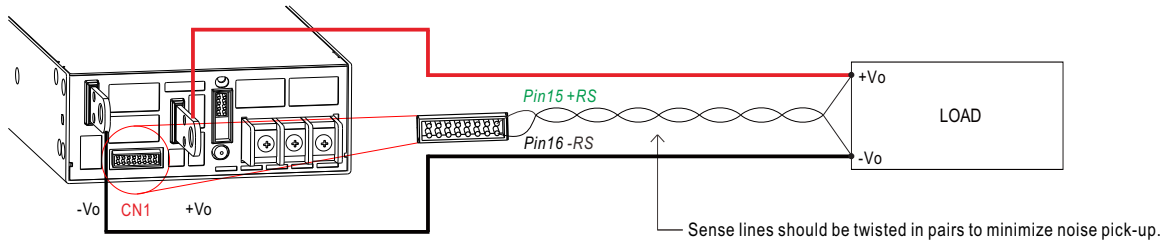

◎ The +RS signal should be connected to the positive terminal of the load whereas -RS signal to the negative terminal.

3.2 Local Sense

※ The +RS,-RS have to be connected to the +Vo(signal), -Vo(signal), respectively, as the following diagram, in order to get the correct output voltage if Remote Sense is not used.

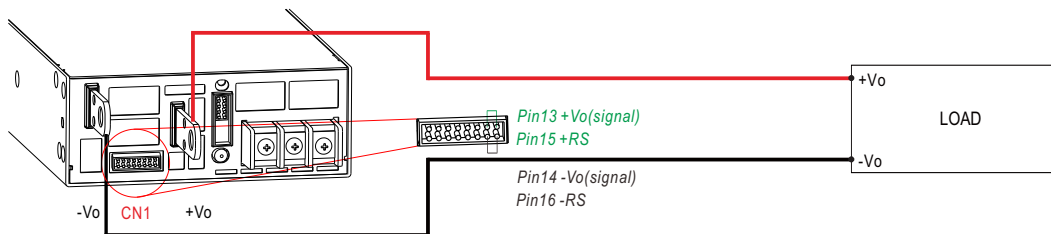

4. Alarm Signal Output

※ There are 2 alarm signals, DC OK and T-ALARM, in TTL signal form, on CN1. These signals are isolated from output. The maximum sink current is 10mA.

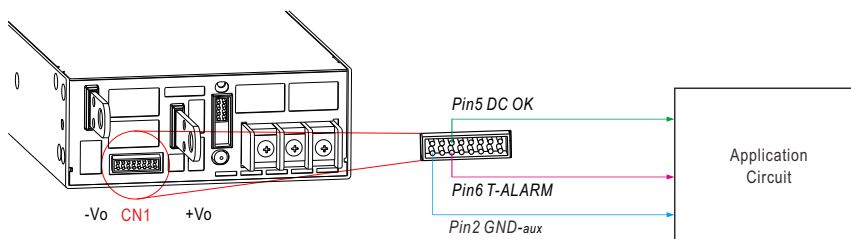

DC OK Fail signal	Power Supply Status
"High" > 3.5~5.5V	Vout ≤ 77%±5%
"Low" < -0.5~0.5V	Vout ≥ 80%±5%

T-ALARM	Power Supply Status
"High" > 3.5~5.5V	OFF(OTP or Fan Fail)
"Low" < -0.5~0.5V	ON(Normal Work)

5. CANBus Communication Interface

NSP-3200 supports CAN 2.0B with maximum 250KHz bus speed, allowing information reading, status monitoring, output trimming, etc. For details, please refer to the User's Manual.

MECHANICAL SPECIFICATION

(Unit: mm , tolerance $\pm 0.5\text{mm}$)

Case No.294A

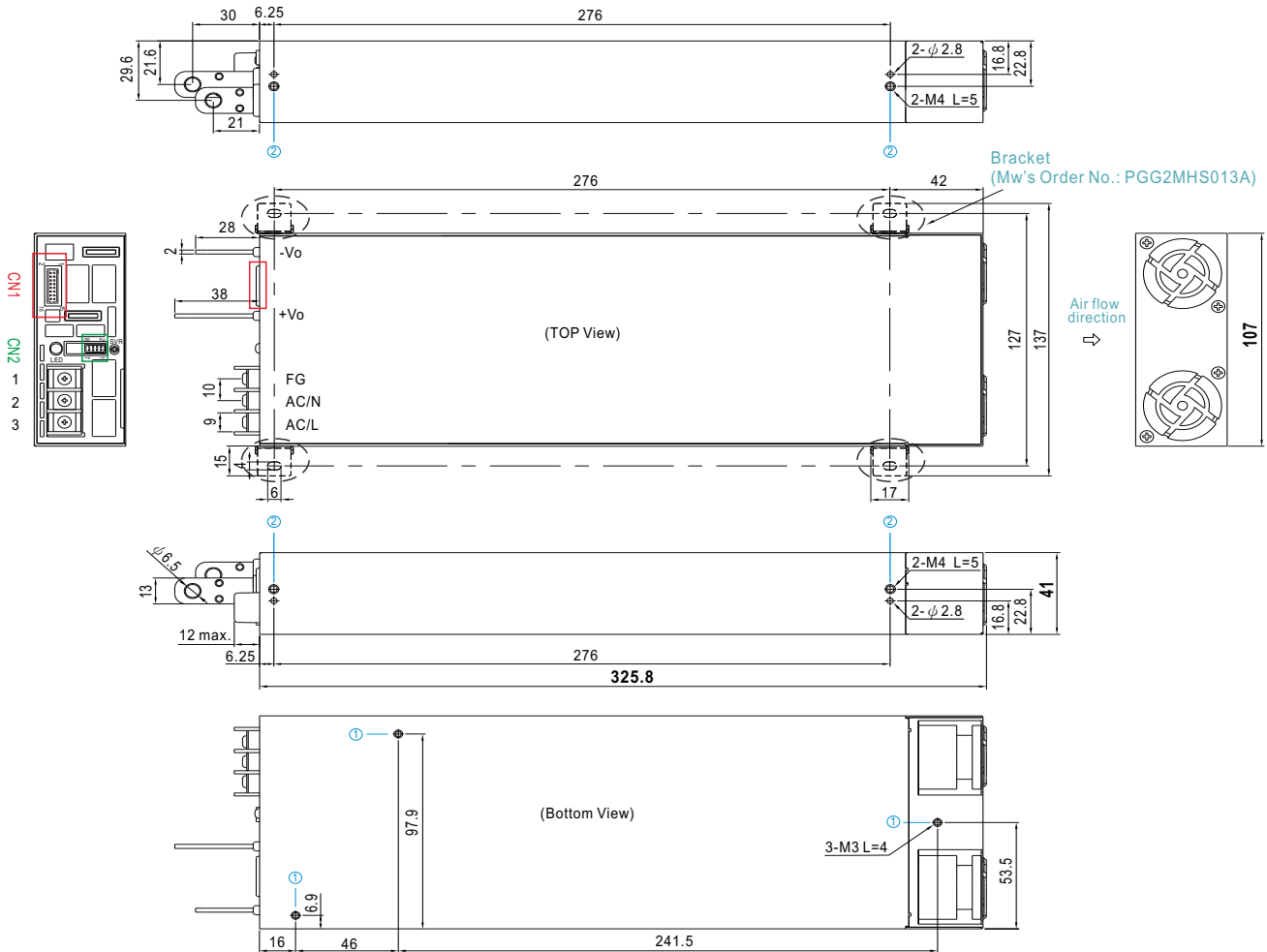

※ Mounting Instruction

Hole No.	Recommended Screw Size	MAX. Penetration Depth L	Recommended mounting torque
①	M3	4mm	6~8Kgf-cm
②	M4	5mm	7~10Kgf-cm

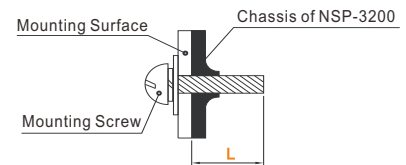

※ Control Pin No. Assignment(CN1) : HRS DF11-16DP-2DS or equivalent

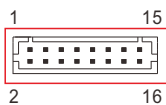

Mating Housing	HRS DF11-16DS or equivalent
Terminal	HRS DF11-**SC or equivalent

Pin No.	Function	Description
1	+12V-aux	Auxiliary voltage output, 10.6~13.2Vdc, referenced to GND-aux (pin2). The maximum load current is 0.8A. This output has the built-in "Oring diodes" and is not controlled by "Remote ON-OFF".
2	GND-aux	Auxiliary voltage output GND. The signal return is isolated from the output terminals (+Vo & -Vo).
3	+5V-aux	This pin is use for remote ON-OFF usage only.
4	R.C	The unit can turn the output ON/OFF by electrical signal or dry contact between <i>Remote ON/OFF</i> and +5V-aux. (Note.2) Short (4.5 ~ 5.5Vdc) : Power ON ; Open (-0.5 ~ 0.5Vdc) : Power OFF ; The maximum input voltage is 5.5Vdc.
5	DC-OK	High (3.5 ~ 5.5Vdc) : When the $V_{out} \leq 77\% \pm 5\%$. Low (-0.5 ~ 0.5Vdc) : When $V_{out} \geq 80\% \pm 5\%$. The maximum sourcing current is 10mA and only for output. (Note.2)
6	T-ALARM	High (3.5 ~ 5.5Vdc) : When the internal temperature exceeds the limit of temperature alarm, or when Fan fails. Low (-0.5 ~ 0.5Vdc) : When the internal temperature is normal, and when Fan works normally. The maximum sourcing current is 10mA and only for output(Note.2)
7,8,9	A0,A1,A2	CANBus interface address lines. (Note.1)
10,11	NC	Retain for future use.
12	PV	Connection for output voltage programming. (Note.1)
13	+Vo(Signal)	Positive output voltage signal. It is for local sense; it cannot be connected directly to the load.
14	-Vo(Signal)	Negative output voltage signal. It is for local sense and certain function reference; it cannot be connected directly to the load.
15	+RS	Positive sensing for remote sense.
16	-RS	Negative sensing for remote sense.

Note1: Non-isolated signal, referenced to [-Vo(signal)].

Note2: Isolated signal, referenced to [GND-aux].



3200W AC/DC High Reliable Industrial Enclosed Type Power Supply **NSP-3200** series

※ LED Status Indicators

LED	Description
Green	The power supply functions normally.
Red	The LED will present a constant red light when the abnormal status (OTP, OLP, fan fail) arises.
Red (Flashing)	The LED will flash with the red light when the internal temperature reaches 60°C; under this condition, the unit still operates normally without entering OTP. (In the meantime, an alarm signal will be sent out through the CANBus interface.)

※ AC Input Terminal Pin No. Assignment

Pin No.	Assignment	Diagram	Screw thread	Maximum mounting torque
1	FG \perp		M3.5	8Kgf-cm
2	AC/N			
3	AC/L			

※ Control Pin No. Assignment(CN2) : HRS DF11-8DP-2DS or equivalent

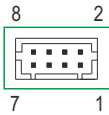

Mating Housing	HRS DF11-8DS or equivalent
Terminal	HRS DF11-**SC or equivalent

Pin No.	Function	Description
1,2,3,4	NC	For standard model: Retain for future use.
5,6	-Vo (Signal)	Negative output voltage signal. It is for local sense and certain function reference; it cannot be connected directly to the load.
7	CANH	For CANBus model: Data line used in CANBus interface. (Note)
8	CANL	For CANBus model: Data line used in CANBus interface. (Note)

Note: Isolated signal, referenced to [GND-aux].

■ Accessory List

No.	Item	Quantity	
1	Control function interface(CN1) mating wire along with NSP-3200 (standard accessory)	<p>UL1007 26AWG HRS DF11-16DS or equivalent</p>	1pcs/per model
2	Bracket Mw's Order No.: PGG2MHS013A (By request accessory, should ordered seperately)		4pcs/per model (Please refer to Installation Diagram)



3200W AC/DC High Reliable Industrial Enclosed Type Power Supply **NSP-3200** series

■ Installation Diagram

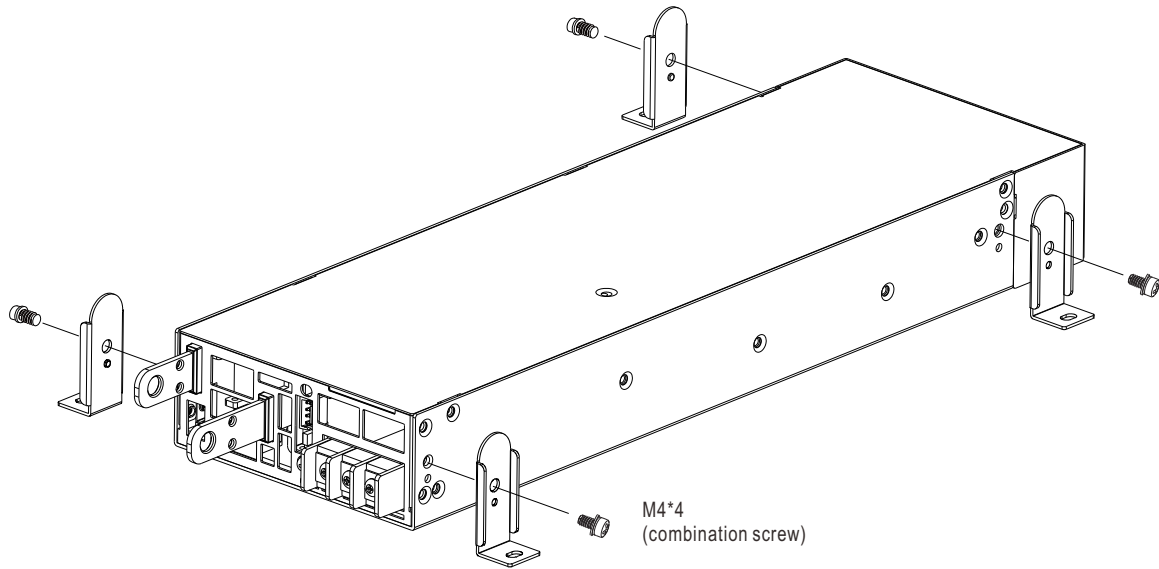

■ Installation Manual

Please refer to : <http://www.meanwell.com/manual.html>