

DC-DC CONVERTER ACR120/Ks,Ksl,Ksl-o

RAILWAY CONVERTER.

FOR CHASSIS MOUNTING



HIGHLIGHTS

- + Output Power up to 150 Watts**
- + Efficiency up to 93%
- + Wide Input Range
- + Wide Temperature Range
- + Hold-up-time > 10ms
- + RoHS compliance
- + According to EN50155

INPUT

Input Voltage Nominal	110 VDC, 24 VDC
Input Voltage Operating	77,0-137,5 VDC, 16,8-30 VDC
Input Voltage Range	66,0-154 VDC, 14,4-34 VDC (t ≤ 1,0 sec.) Class 1C
No Load Input Current	See table page 2

OUTPUT

Output Voltage	12 V / 24 V (other voltages on request)
Initial Set Accuracy	< 2 % (no load) *
Minimum Load	No minimum load
Short circuit	Continuous short circuit proof
Line Regulation	< 0,5 %
Load Regulation	< 2 % (0% - 100% load)
Ripple & Noise	< 2 % pk-pk, 20 MHz bandwidth *
Start Time	< 900 ms at 110V _{in} <200ms at 24V _{in}
Max. Output Capacitance	500 µF x I _{out nom}
Temperature Coefficient	< 0.01 %/°C

FEATURES

Enable Signal	See page 6
Active Inrush Current Limitation	Max. 6A at 110 V _{in} , max 24A at 24 V _{in} (at t > 100µs)
Active Reverse Polarity Protection	Max. 160 V at 110 V _{in} , max. 30 V at 24 V _{in} > 10 ms (at P _{out} ≤ 120 W, 110 V _{in} (Class S2))
Hold-up-time	> 10 ms (at P _{out} ≤ 100 W, 24 V _{in} (Class S2))
Adjust	See page 6
Tracking	See page 6

PROTECTION

Over Voltage Protection (OVP)	110-130 % V _{out nom}
Over Current Protection (OCP)	See table page 2
Over Temperature Protection (OTP)	Shutdown at +105-110°C PCB-temp. with about 5°C hysteresis and auto recovery. 110-115°C for Ksl-O

GENERAL

Product Standard	EN 50155:2017
Isolation	2200 VDC Input to Output 2200 VDC Input to Earth (Chassis) 750 VDC Output to Earth (Chassis)
Pollution Degree	PD2 according to EN 50124-1:2017
Switching Frequency	Typ. 120 kHz
Dimensions [mm]	113,5 x 35 x 46
Weight	approx. 320 g, approx 170g for Ksl-O
MTBF / Useful Life	TBD / Class L4 (20 years)
Fire & Smoke	EN 45545-2:2016-02 HL3 (R25)

ENVIRONMENTAL

Operating Ambient Temp.	-40°C to +85°C (Class OT4+ST1,ST2)
Storage Temperature	-55°C to +100°C
Rapid Temperature	Class H1
Altitude	Up to 2000m
Vibration / Shock / Bump	EN 61373:2010, Cat. 1B

EMC

EMC Standard	EN 50121-3-2:2016
Conducted Emissions	EN 55011:2018**
Radiated Emissions	EN 55011:2018**
ESD Immunity	EN 61000-4-2:2009, level 3 (6kV/8kV), Criteria A
Burst	EN 61000-4-4:2012, level 3 (2kV), Criteria A
Surge	EN 50121-3-2:2016, EN 61000-4-5:2014 Crit.B
Conducted Immunity	EN 61000-4-6:2014, level 3 (10V), Criteria A
Radiated Immunity	EN 61000-4-3:2006+A1:2007+A2:2010, 20V/m, Criteria A
Safety	IEC 62368-1:2014 + AC:2015

* For T_{amb} = 25°C, V_{in nom}, I_{out nom}

** In built-in condition the devices may show different EMC properties.

TECHNICAL DATA

For $T_{amb} = 25^{\circ}C$, $V_{in nom}$, $I_{out nom}$, unless otherwise specified

SPECIFICATION Input 14,4 - 34 VDC

TYPE			ACR120/Ks (with pin cover)	ACR120/Ksl-O
ORDER NUMBER			72 31 24 0229 3	72 31 24 0243 3
CHARACTERISTIC		Unit		
INPUT	Input Voltage Nominal	V	24	24
	Input Voltage Range	V	14,4...34	14,4...34
	Under Voltage Turn-on	V	15...16,5	15...16,5
	Under Voltage Turn-off	V	13...14,3	13...14,3
	Input Current @ Full Load	A	5,5	4,4
	Input Current @ No Load	A	0,04	0,04
	Recommended External Fuse	A	10AT	8AT
OUTPUT	Output Voltage Nominal	V	24	24
	Output Current Nominal	A	5	4
	Output Power	W	120	96
	Efficiency @ Full Load (typical)	%	91	91
	Output Current limit	A	6,5...8,5	5,2...7
	Short Circuit Current (typical)		11 (pulse approx. 1Hz)*	7 (pulse approx. 1Hz)*
	Transient Response 25 % / 75 % Load Step Recovery Time < 1 ms	mV	±480	±480

* Pulsating current time duration 50 ms

SPECIFICATION Input 66 - 154 VDC

TYPE			ACR120/Ks	ACR120/Ks (with pin cover)
ORDER NUMBER			77 31 12 0522 4	77 31 12 0529 5
CHARACTERISTIC		Unit		
INPUT	Input Voltage Nominal	V	110	
	Input Voltage Range	V	66...154	
	Under Voltage Turn-on	V	67,0...76,0	
	Under Voltage Turn-off	V	58,0...66,0 (66,0V < V_{in} < 77,0V at $t > 1$ sec.)	
	Input Current @ Full Load	A	1,45	
	Input Current @ No Load	A	0,04	
	Recommended External Fuse	A	3,15	
OUTPUT	Output Voltage Nominal	V	12	12
	Output Current Nominal	A	12	12
	Output Power	W	144	144
	Efficiency @ Full Load (typical)	%	92	92
	Output Current limit	A	13...17	13...17
	Short Circuit Current (typical)		30 (pulse approx.. 1Hz)	30 (pulse approx.. 1Hz)
	Transient Response 25 % / 75 % Load Step Recovery Time < 1 ms	mV	±240	±240

TECHNICAL DATA

For $T_{amb}=25^{\circ}C$, $V_{in nom}$, $I_{out nom}$, unless otherwise specified

SPECIFICATION Input 66 – 154 VDC

	TYPE		ACR120/Ks	ACR120/Ks (with pin cover)	ACR120/Ksl	ACR120/Ksl-O
	ORDER NUMBER		77 31 24 0522 9	77 31 24 0529 1	77 31 24 0528 6	77 31 24 0543 1
	CHARACTERISTIC	Unit				
INPUT	Input Voltage Nominal	V	110			
	Input Voltage Range	V	66...154			
	Under Voltage Turn-on	V	67,0...76,0			
	Under Voltage Turn-off	V	58,0...66,0 (66,0V < V_{in} < 77,0V at $t > 1$ sec.)			
	Input Current @ Full Load	A	1,45			
	Input Current @ No Load	A	0,04			
	Recommended External Fuse	A	3,15			
OUTPUT	Output Voltage Nominal	V	24	24	24	24
	Output Current Nominal	A	6,25	6,25	6,25	4
	Output Power	W	150	150	150	96
	Efficiency @ Full Load (typical)	%	93	93	93	93
	Output Current limit	A	7,2...9,0	7,2...9,0	7,2...9,0	7,2...9,0
	Short Circuit Current (typical)	A	16 (pulse approx. 1Hz)*	16 (pulse approx. 1Hz)*	16 (pulse approx. 1Hz)*	16 (pulse approx. 1Hz)*
	Transient Response 25 % / 75 % Load Step Recovery Time < 1 ms	mV	±480	±480	±480	±480

TECHNICAL DATA

For $T_{amb} = 25^{\circ}\text{C}$, $V_{in\ nom}$, $I_{out\ nom}$, unless otherwise specified

MECHANICAL DETAILS

1. Dimensions are in mm
2. Unless otherwise specified, general tolerances $\pm 0,5$ are for values in brackets (XX)
Values not in brackets are according to ISO-2768-1m

Coating Class: PC2 (for Ksl-o)
Protection Degree: PD2

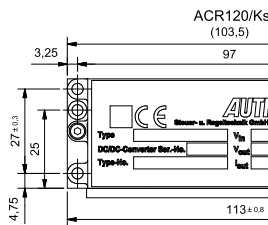
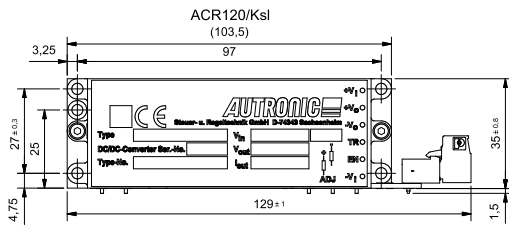
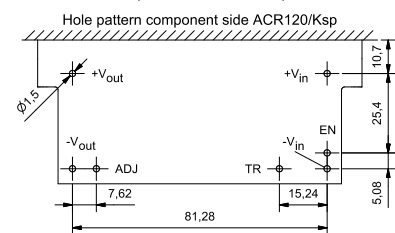
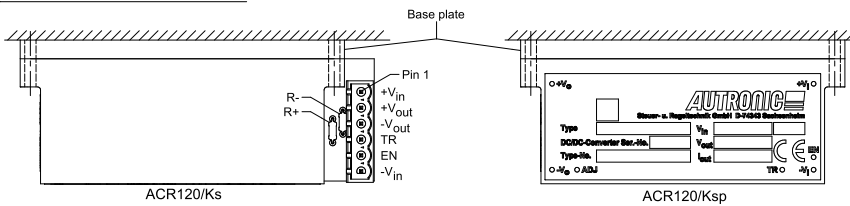
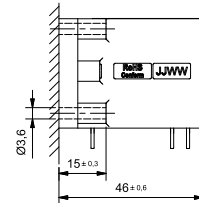
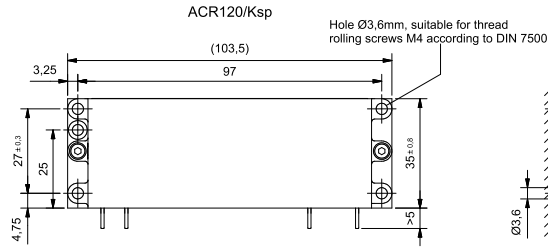
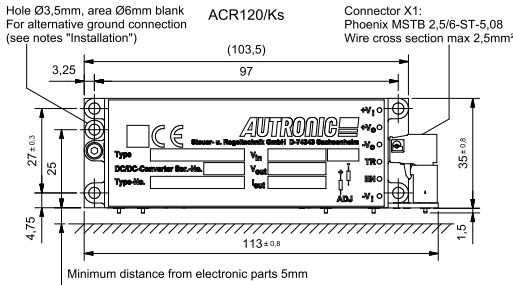

For models with pin cover

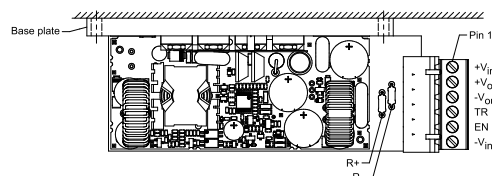
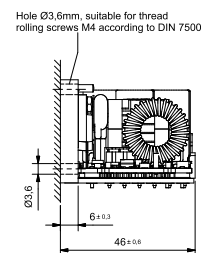
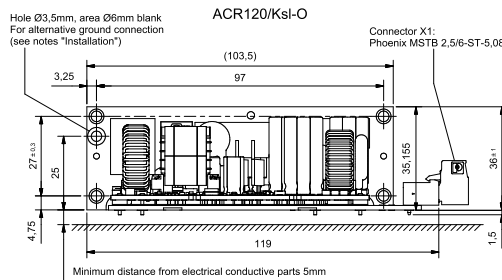
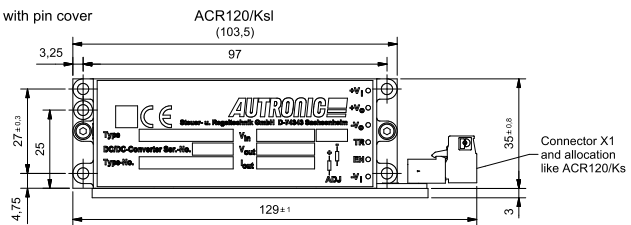

Resin compound: Polyurethane, UL94-V0, EN45545-2:2016-02 HL-HL2-HL3 (R24) (no resin for Ksl-O, coating: Lackwerke Peters ELPEGUARD SL 1307-FLZ/2)

TECHNICAL DATA

For $T_{amb} = 25^{\circ}\text{C}$, $V_{in\ nom}$, $I_{out\ nom}$, unless otherwise specified

PINNING

Pin	Function
X1-1	+V _{in}
X1-2	+V _{out}
X1-3	-V _{out}
X1-4	TR
X1-5	EN
X1-6	-V _{in}
not connected on X1	ADJ

NOTES

Installation instructions:

The converters have to be installed according to the guidelines currently in force, like other open electronic component assemblies. Attention must be paid to sufficient ventilation, carry off heat, fastening and protection against accidental contact. Plug in not under voltage. The mounting surface must be flat and able to remove the thermal energy of the baseplate (baseplate temperature must not exceed +90°C). The baseplate has to be grounded by using thread rolling screws M 4 according to DIN 7500. An alternative connection to ground can be realized by a special mounting hole, which is free of anodizing surface.

Fault protection: For input protection a time-lag fuse corresponding to IEC 60127-2 must be installed. For recommended rating of the fuse refer to specification table above. Pay attention on sufficient current source in case of short circuit. In some applications 2 fuses would be necessary, one in each input line.

BLOCK DIAGRAM

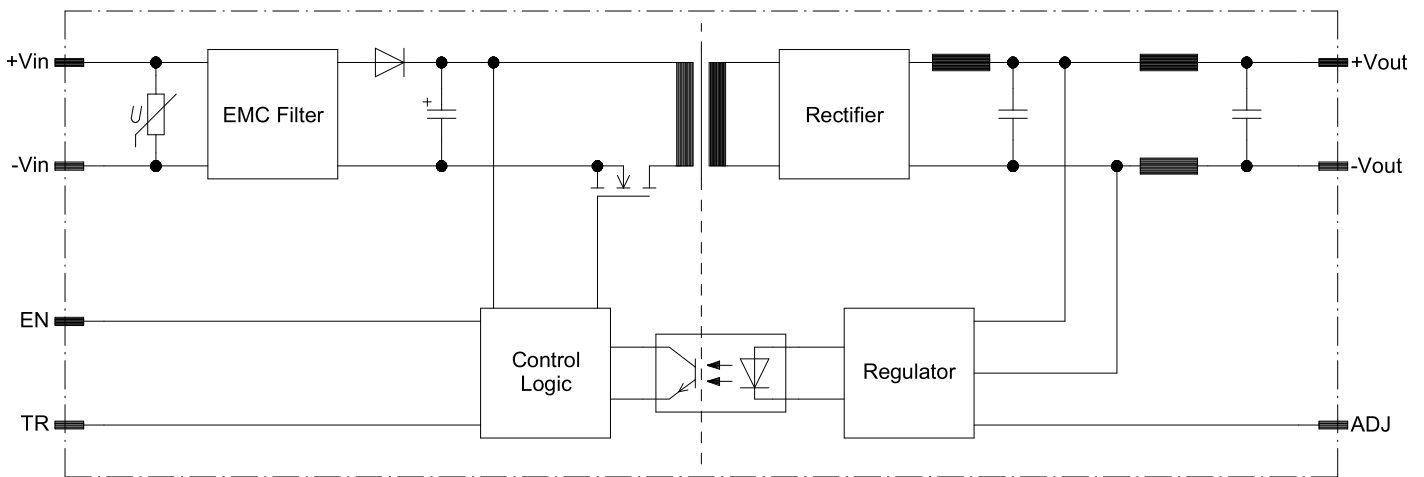

DESCRIPTION OF FEATURES

ENABLE SIGNAL

The module may be disabled by pulling EN below 1,0 V with respect to the –Input.

This may be done with an open collector transistor, relay, optocoupler, or an external control voltage (V1).

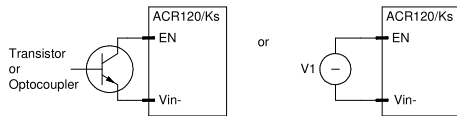

Open-collector:

Leakage current $\leq 100 \mu\text{A}$

Min. $V_{\text{CEO}} \geq 20 \text{ V}$

V1:

3...5 V (Enable active)

0...0,8 V (Enable inactive)

When not in use, leave Enable pin not-connected.

ADJUST

Inserting a wire to "R+" increases the output voltage of about 8%. Intermediate values are obtained by means of a resistor. Adding a resistor for "R-" ensures that the output may be lowered by max. 8%.

When not in use, leave Adjust pin not-connected.

TRACKING

If the TR pins of two or more converters are connected, the output voltages in case of short-circuit or overload go synchronously down.

The module may be disabled by pulling EN below 0,8 V with respect to the –Input.

This may be done with an open collector transistor, relay, optocoupler, or an external control voltage (V1).

For parallel connection a minimum load is required. External adjustment of the output voltages could be necessary. Detailed information and recommendations on demand.

When not in use, leave Tracking pin not-connected.

CHANGE HISTORY

Revision	Date	Author	Modification
a05	2020-05-13	Eigner	Change for new Product Standard EN50155:2017