

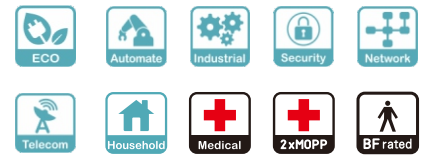

# 100W AC/DC High Reliable Multi-Industries Enclosed Type Power Supply **NSP-100** series

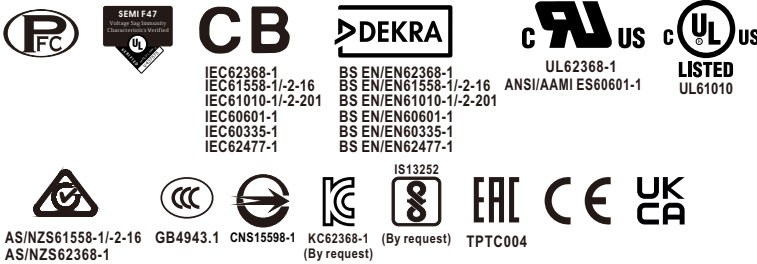
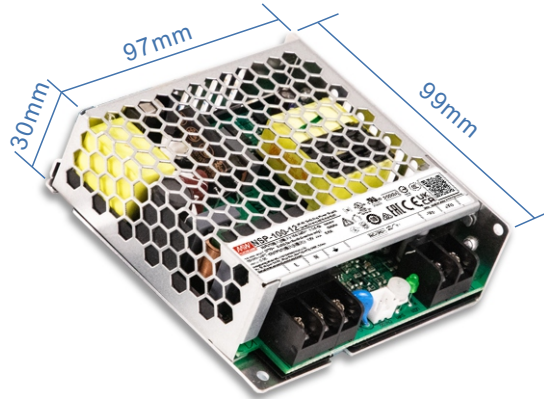

## ■ Features

- 85~305Vac input with PFC(277Vac available)
- No load power consumption <0.3W~0.5W by R.C.
- Global certificates in multi-fields (ITE 62368-1, Medical 60601-1, Household 60335-1, Industrial 61558-1/2-16/61010-1, Energy converter 62477-1)
- 200% peak power capability(12~60V models)
- High efficiency up to 92%
- -40~85°C wide range operation temperature(> +60°C derating)
- Extremely low leakage current<350µA, 2 x MOPP, suitable for BF medical applications
- Built-in constant current limiting circuit
- Protections: Short circuit / Overload / Over voltage / Over temperature
- Fanless design for noise sensitive applications
- Built-in remote ON/OFF control
- Over voltage category III (OVC III)
- Operating altitude up to 5000 meters
- Conformal coating
- 5 years warranty

## ■ Description

The NSP-100 series is a 100W AC/DC power supply with PFC function, designed for high reliability and suitable for multiple industries. Key features include: compact size (99\*97\*30 mm) for better space utilization in system installations, ultra-wide input range of 85~305Vac for global compatibility, up to 92% efficiency and low standby power consumption(<0.3W~0.5W) for energy-saving and carbon reduction, constant current design with 200% peak power capability, fanless design, wide operating temperature range from -40 to +85°C (+60°C at full load), compliance with OVCIII, built-in Remote Control, internal PCB coating, complete protections, certifications for multiple safety standards including 62368-1, 60601-1, 61558-1, 60335-1, 62477-1, and 61010-1, as well as 2 X MOPP compliance and extremely low leakage current(<350µA). It is suitable for BF-rated medical equipment and comes with a 5-years warranty, making it a highly cost-effective solution for industrial power supply needs.

## ■ Model Encoding

**NSP -100 - 24**

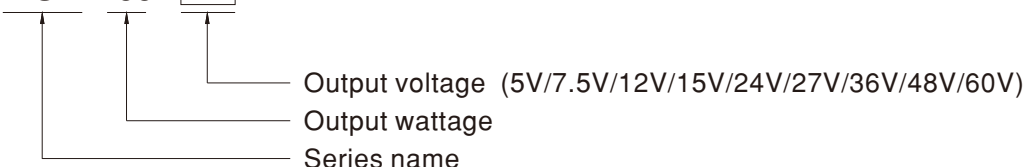

## ■ Applications

- Industrial automation machinery/control system
- Security system
- Mechanical and electrical equipment
- Electronic instruments, equipments or apparatus
- Network equipment
- Telecom devices
- Power sourcing equipment of PoE
- Home automation
- Medical devices

## ■ GTIN CODE

MW Search: <https://www.meanwell.com/serviceGTIN.aspx>



# 100W AC/DC High Reliable Multi-Industries Enclosed Type Power Supply **NSP-100** series

SPECIFICATION		NSP-100-5	NSP-100-7.5	NSP-100-12	NSP-100-15	NSP-100-24	NSP-100-27	NSP-100-36	NSP-100-48	NSP-100-60
<b>OUTPUT</b>										
DC VOLTAGE		5V	7.5V	12V	15V	24V	27V	36V	48V	60V
RATED CURRENT		20A	13.4A	8.5A	6.7A	4.2A	3.7A	2.8A	2.1A	1.7A
CURRENT RANGE		0 ~ 20A	0 ~ 13.4A	0 ~ 8.5A	0 ~ 6.7A	0 ~ 4.2A	0 ~ 3.7A	0 ~ 2.8A	0 ~ 2.1A	0 ~ 1.7A
RATED POWER		100W	100.5W	102W	100.5W	100.8W	99.9W	100.8W	100.8W	102W
PEAK	CURRENT(5 sec.)	N/A	N/A	16.7A	13.4A	8.4A	7.4A	5.6A	4.2A	3.4A
	POWER(5 sec.)	N/A	N/A	200W	200W	200W	200W	200W	200W	200W
RIPPLE & NOISE (max.) Note.2		150mVp-p	150mVp-p	150mVp-p	150mVp-p	200mVp-p	240mVp-p	240mVp-p	240mVp-p	300mVp-p
VOLTAGE ADJ. RANGE		4.7 ~ 5.5V	6.8 ~ 9V	10.8 ~ 14V	15 ~ 19V	21 ~ 26V	26 ~ 32V	32 ~ 43V	44 ~ 57V	54 ~ 72V
VOLTAGE TOLERANCE Note.3		±2.0%	±2.0%	±2.0%	±2.0%	±1.0%	±1.0%	±1.0%	±1.0%	±1.0%
LINE REGULATION		±0.5%	±0.5%	±0.5%	±0.5%	±0.5%	±0.5%	±0.5%	±0.5%	±0.5%
LOAD REGULATION		±1.0%	±1.0%	±0.5%	±0.5%	±0.5%	±0.5%	±0.5%	±0.5%	±0.5%
SETUP, RISE TIME		1500ms, 80ms/115Vac		1000ms, 80ms/230Vac		1000ms, 80ms/277Vac				
HOLD UP TIME (Typ.)		16ms at full load								
<b>INPUT</b>										
VOLTAGE RANGE Note.4		85 ~ 305Vac 120 ~ 431Vdc								
NO LOAD POWER CONSUMPTION(Typ.)	Remote Power OFF	0.3W/115Vac		0.5W/230Vac		0.5W/277Vac				
	Remote Power ON	2W/115Vac		2W/230Vac		2W/277Vac				
FREQUENCY RANGE		47 ~ 63Hz								
POWER FACTOR (Typ.)		PF>0.98/115Vac, PF>0.93/230Vac, PF>0.9/277Vac at full load								
EFFICIENCY (Typ.)		90%	91%	92%	92%	91%	91%	91.5%	92%	92%
AC CURRENT (Typ.)		1.1A/115Vac		0.52A/230Vac		0.45A/277Vac				
INRUSH CURRENT (Typ.)		COLD START 20A/115Vac		35A/230Vac		45A/277Vac				
LEAKAGE CURRENT		Earth leakage current <350µA(rms)@277Vac, touch current<100µA(rms) @ 277Vac								
<b>PROTECTION</b>										
SHORT CIRCUIT	5V	Hiccup mode,recovers automatically after fault condition is removed								
	7.5V	Constant current limiting for more than 5 seconds and then shut down o/p voltage, AC re-power on to recover								
	12V-60V	Constant current limiting for more than 5 seconds (Vout<30%) and then shut down o/p voltage, AC re-power on to recover								
OVERLOAD	5V	105%~170% rated output power; Hiccup mode,recovers automatically after fault condition is removed								
	7.5V	105%~150% rated output power; Constant current limiting for more than 5 seconds and then shut down o/p voltage, AC re-power on to recover								
	12V ~ 60V	Normally works within 105 ~ 200% rated output power for more than 5 seconds and then constant current limiting without shutdown (Vout>30%), recovers automatically after fault condition is removed, or shut down o/p voltage when Vout<30%,AC re-power on to recover >200% rated power, constant current limiting (Vout>30%)with auto-recovery after fault condition is removed, or shut down o/p voltage when Vout<30%,AC re-power on to recover								
OVER VOLTAGE	5.8 ~ 7.5V	9.2 ~ 13V	15 ~ 19V	20 ~ 25V	28 ~ 36V	33~ 42V	44 ~ 54V	58~ 70V	73~ 86V	
	Protection type : Shut down o/p voltage, AC re-power on to recover									
OVER TEMPERATURE		Shut down o/p voltage, AC re-power on to recover								
<b>FUNCTION</b>										
REMOTE CONTROL		POWER ON: RC+~RC-		0~0.8Vdc or open						
		POWER OFF: RC+~RC-		3.3~10 Vdc by external voltage						
<b>ENVIRONMENT</b>										
WORKING TEMP.		-40 ~ +85°C (Refer to "Derating Curve")								
WORKING HUMIDITY		20 ~ 90% RH non-condensing								
STORAGE TEMP., HUMIDITY		-40 ~ +85°C, 10 ~ 95% RH non-condensing								
TEMP. COEFFICIENT		±0.05%/°C (0 ~ 60°C)								
VIBRATION		10 ~ 500Hz, 2G 10min./1cycle, 60min. each along X, Y, Z axes								



# 100W AC/DC High Reliable Multi-Industries Enclosed Type Power Supply **NSP-100** series

SAFETY & EMC(Note 6)			
<b>SAFETY STANDARDS</b>	CB DEKRA UL RCM CCC BSMI EAC KC/BIS	IEC62368-1, IEC60335-1, IEC61558-1/2-16, IEC61010-1/2-201, IEC60601-1; IEC62477-1 BS EN/EN62368-1, BS EN/EN60335-1, BS EN/EN61558-1/2-16, BS EN/EN61010-1/2-201, BS EN/EN60601-1(3.2 Version);BS EN/EN62477-1 UL62368-1, ANSI/AAMI ES60601-1(3.2 Version),UL61010-1/2-201 AS/NES 62368-1, AS/NES61558-1/2-16 GB4943.1 CNS15598-1 TP TC 004 approved; <b>KC62368-1 and BIS IS 13252 (Part 1) :2010 certified, no stock by request, contact sale for inquires</b>	
<b>ISOLATION RESISTANCE</b>	Primary-Secondary: <b>2xMOPP</b> , Primary-Earth: 1xMOPP, <b>Secondary-Earth: 1xMOPP</b>		
<b>OVER VOLTAGE CATEGORY</b>	IEC/EN 61558-1/2-16 (OVC III, altitude up to 2000M) IEC/EN/UL 62368-1 (OVC II, altitude up to 5000M) IEC/EN 60335-1 (OVC II, altitude up to 5000M) IEC/EN 60601-1 (OVC II, altitude up to 4000M) IEC/EN 61010-1/2-201 (OVC II, altitude up to 5000M)		
<b>SAFETY EXTRA-LOW VOLTAGE(SELV)</b>	IEC/EN 61558-2-16 (SELV, 5 ~ 36V) IEC/EN 60335-1 (SELV, 5 ~ 36V) IEC/EN/UL 62368-1 (SELV/ES1, 5 ~ 36V)		
<b>WITHSTAND VOLTAGE</b>	I/P-O/P: <b>4.2KVac</b> I/P-FG: <b>2.1KVac</b> O/P-FG: <b>1.5KVac</b>		
<b>ISOLATION RESISTANCE</b>	I/P-O/P, I/P-FG, O/P-FG: 100M Ohms / 500VDC / 25°C / 70% RH		
<b>EMC EMISSION</b>	<b>Parameter</b>	<b>Standard</b>	<b>Test Level / Note</b>
	Conducted	BS EN/EN55032(CISPR32), CNS 15936	Class B
		BS EN/EN55014-1(CISPR14-1)	
		BS EN/EN55011(CISPR11)	Class B
	Radiated	BS EN/EN55032(CISPR32), CNS 15936	Class B
		BS EN/EN55014-1(CISPR14-1)	
		BS EN/EN55011(CISPR11)	Class B
	Harmonic Current	BS EN/EN61000-3-2(IEC61000-3-2)	Class A
Voltage Flicker	BS EN/EN61000-3-3(IEC61000-3-3)	-----	
BS EN/EN55035(CISPR35),BS EN/EN61000-6-2(IEC61000-6-2),BS EN/EN60601-1-2(IEC60601-1-2), BS EN/EN55014-2(CISPR14-2)			
<b>EMC IMMUNITY</b>	<b>Parameter</b>	<b>Standard</b>	<b>Test Level / Note</b>
	ESD	BS EN/EN61000-4-2	Level 4, <b>15KV</b> air ; Level 4, <b>8KV</b> contact
	Radiated	BS EN/EN61000-4-3	Level 3, 10V/m(80MHz~2.7GHz) Table 9, 9~28V/m(385MHz~5.78GHz)
	EFT / Burst	BS EN/EN61000-4-4	Level 3, 2KV
	Surge	BS EN/EN61000-4-5	Level 4, 2KV/Line-Line 4KV/Line-Earth
	Conducted	BS EN/EN61000-4-6	Level 3, 10V
	Magnetic Field	BS EN/EN61000-4-8	Level 4, 30A/m
	Voltage Dips and Interruptions	BS EN/EN61000-4-11	>95% dip 0.5 periods, 30% dip 25 periods, >95% interruptions 250 periods
<b>OTHERS</b>			
<b>MTBF</b>	2163.5 K hrs min. Telcordia SR-332 (Bellcore) ; 250.4 K hrs min. MIL-HDBK-217F (25°C)		
<b>DIMENSION (L*W*H)</b>	<b>99*97*30mm</b>		
<b>PACKING</b>	0.27Kg;45pcs/13.2Kg/0.91CUFT		
<b>NOTE</b>			
<p>1. All parameters NOT specially mentioned are measured at 230Vac input, rated load and 25°C of ambient temperature.</p> <p>2. Ripple &amp; noise are measured at 20MHz of bandwidth by using a 12" twisted pair-wire terminated with a 0.1uF &amp; 47uF parallel capacitor.</p> <p>3. Tolerance: includes set up tolerance, line regulation and load regulation.</p> <p>4. Derating may be need under low input voltages. Please refer to "STATIC CHARACTERISTIC" sections for details.</p> <p>5. The ambient temperature derating of 3.5°C/1000m with fanless models and 5°C/1000m with fan models for operating altitude higher than 2000m(6500ft).</p> <p>6. The power supply is considered a component which will be installed into a final equipment. All the EMC tests are been executed by mounting the unit on a 360mm*360mm metal plate with 1mm of thickness. The final equipment must be re-confirmed that it still meets EMC directives. For guidance on how to perform these EMC tests, please refer to "EMI testing of component power supplies." (as available on <a href="https://www.meanwell.com/Upload/PDF/EMI_statement_en.pdf">https://www.meanwell.com/Upload/PDF/EMI_statement_en.pdf</a>)</p> <p>7. RCM is on voluntary basis and meets relevant IEC or AS/NZS standards complying with AS/NZS 4417.1.</p> <p>※ Product Liability Disclaimer: For detailed information, please refer to <a href="https://www.meanwell.com/serviceDisclaimer.aspx">https://www.meanwell.com/serviceDisclaimer.aspx</a></p>			



# 100W AC/DC High Reliable Multi-Industries Enclosed Type Power Supply **NSP-100 series**

## Block Diagram

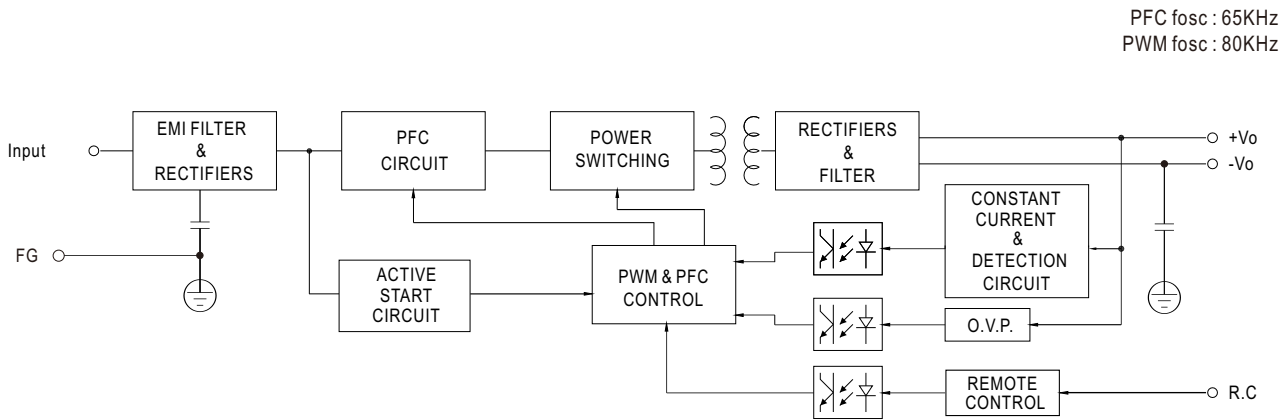

## Derating Curve

Suitable for 100/110/115/120Vac System (85~135Vac)

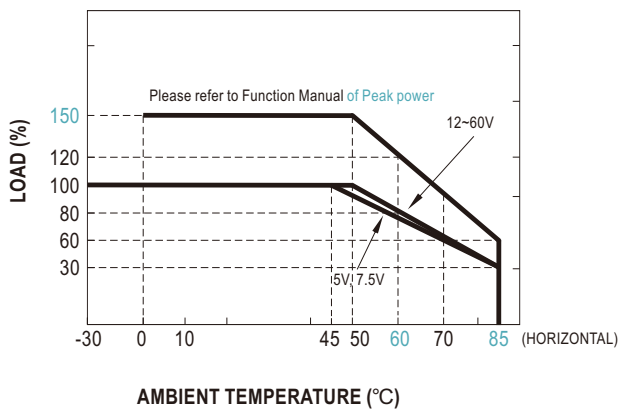

Suitable for 220/230/240/277Vac System (180~305Vac)

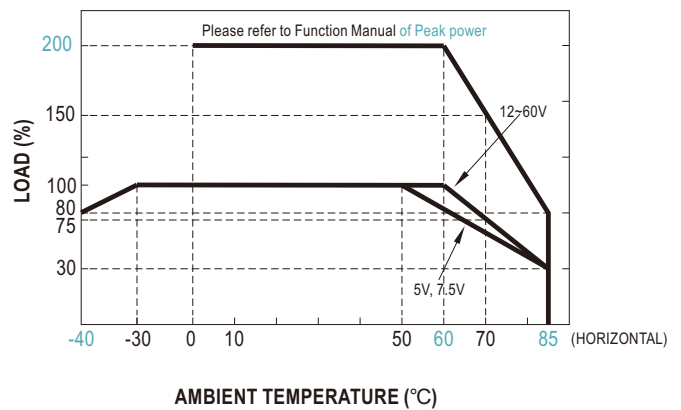

Note: Below 100Vac @ -30°C there may be a restart situation within 3 seconds after power-on

## Output Derating vs Input Voltage

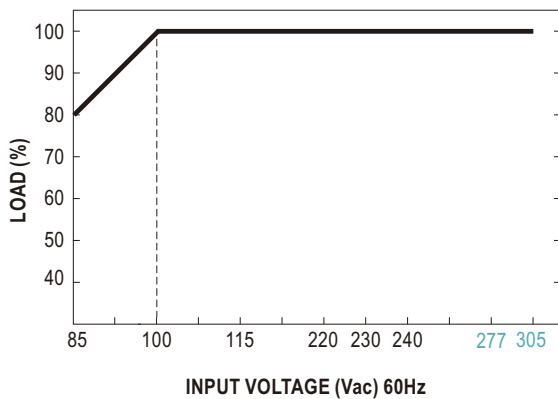



# 100W AC/DC High Reliable Multi-Industries Enclosed Type Power Supply **NSP-100** series

## Function Manual

### 1. Peak Power

$$P_{av} = \frac{P_{pk} \times t + P_{npk} \times (T-t)}{T} \leq P_{rated}$$

$$Duty = \frac{t}{T} \times 100\% \leq 35\%$$

$$t \leq 5 \text{ sec}$$

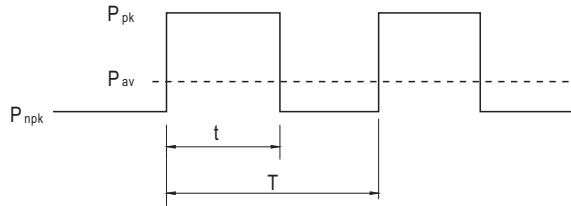

$P_{av}$  : Average output power (W)

$P_{pk}$  : Peak output power (W)

$P_{npk}$  : Non-peak output power (W)

$P_{rated}$  : Rated output power (W)

$t$  : Peak power width (sec)

$T$  : Period (sec)

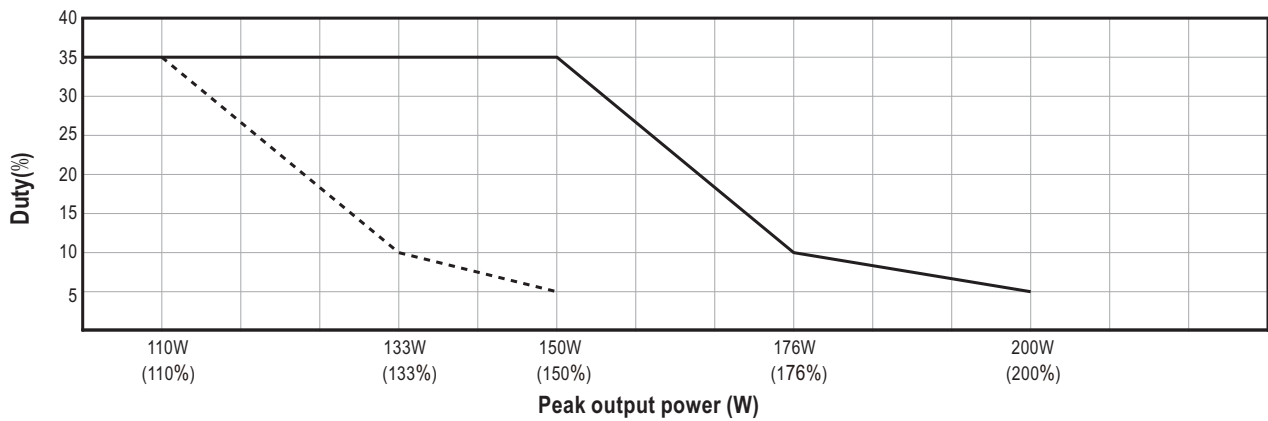
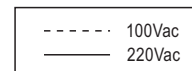

#### For example (24V model) :

$V_{in} = 200V_{ac}$      $Duty_{max} = 5\%$

$P_{av} = P_{rated} = 100W$

$P_{pk} = 200W$

$t \leq 5 \text{ sec}$

$$T \geq \frac{5 \text{ sec}}{5\%} \geq 100 \text{ sec}$$

$$P_{npk} \leq \frac{T P_{av} - t P_{pk}}{T-t}$$

$$P_{npk} \leq 94.7W$$

Note: When the output voltage is adjusted to the upper limit, the peak power is 150% rated power

### 2. Remote Control

The PSU can be turned ON/OFF by using the "Remote Control" function with external switch and auxiliary power

PSU Vo Status	Between RC+(pin1) and RC-(pin2) on CN1
POWER ON	SW open or keep 0~0.8Vdc
POWER OFF	SW short or keep 3.3~10Vdc

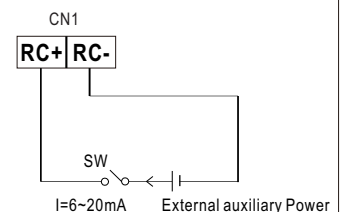
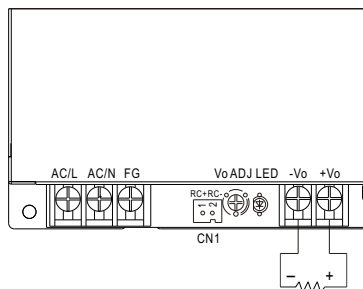



# 100W AC/DC High Reliable Multi-Industries Enclosed Type Power Supply **NSP-100** series

## ■ Mechanical Specification

Case No.240A Unit:mm Tolerance:±1

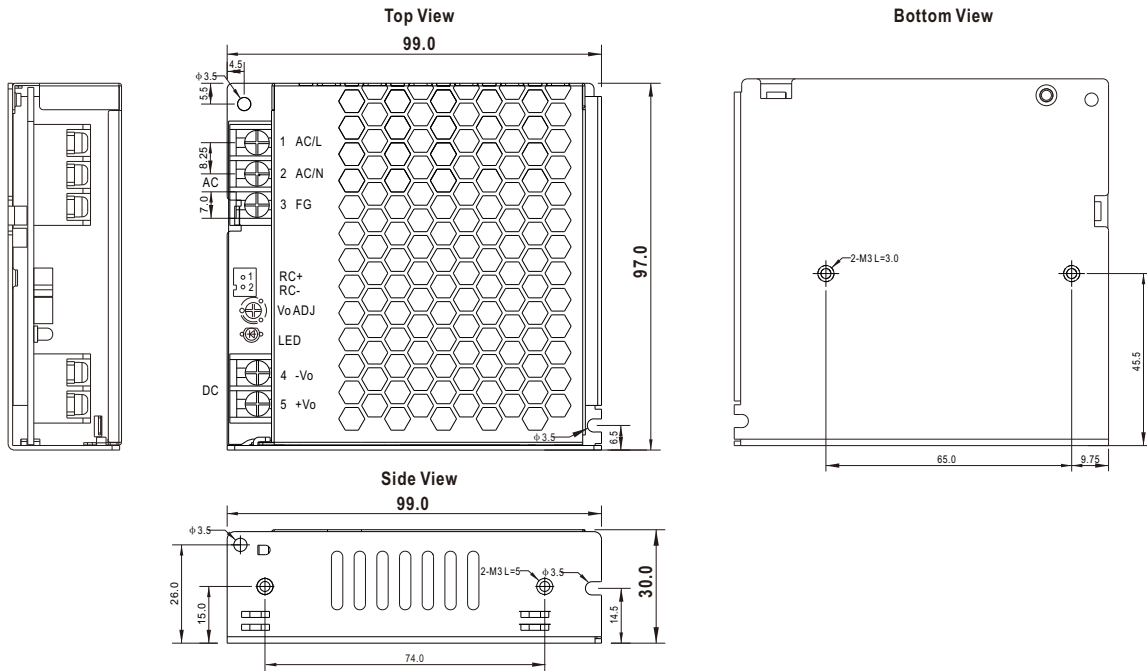

### ※ Input Terminal Pin No. Assignment

Pin No.	Assignment	Diagram	Screw thread	Maximum mounting torque
1	AC/L or DC input +Vin		M3	5Kgf.cm
2	AC/N or DC input -Vin			
3	FG $\pm$			

### ※ DC Output Terminal Pin No. Assignment

Pin No.	Assignment	Diagram	Screw thread	Maximum mounting torque
4	-Vo		M3	5Kgf.cm
5	+Vo			

Remote ON/OFF: JST S2B-XH or equivalent

Pin No.	Assignment	Mating Housing	Terminal
1	RC+	JST XHP or equivalent	JST SXH-001T-P0.6 or equivalent
2	RC-		

## ■ Accessory List

No.	Item	Quantity
1	Control function interface(CN1) mating wire along with NSP-100 (standard accessory)	1pcs/per model
2	Terminal cover MW'S Order NO. :PEE4TBC-02-DG (By request accessory,should ordered separately)	1pcs/per model
3	Terminal cover MW'S Order NO. :PEE4TBC-03-DG (By request accessory,should ordered separately)	1pcs/per model

## ■ Installation Manual

Please refer to : <http://www.meanwell.com/manual.html>